

MIT Open Access Articles

*A novel communication method for
semi-passive RFID based sensors*

The MIT Faculty has made this article openly available. **Please share** how this access benefits you. Your story matters.

Citation: Kalansuriya, Prasanna, Rahul Bhattacharyya, and Sanjay Sarma. "A Novel Communication Method for Semi-Passive RFID Based Sensors." 2014 IEEE International Conference on Communications (ICC) (June 2014).

As Published: <http://dx.doi.org/10.1109/ICC.2014.6884264>

Publisher: Institute of Electrical and Electronics Engineers (IEEE)

Persistent URL: <http://hdl.handle.net/1721.1/97705>

Version: Author's final manuscript: final author's manuscript post peer review, without publisher's formatting or copy editing

Terms of use: Creative Commons Attribution-Noncommercial-Share Alike



A novel communication method for semi-passive RFID based sensors

Prasanna Kalansuriya, Rahul Bhattacharyya, and Sanjay Sarma
Auto-ID Labs, Massachusetts Institute of Technology, Cambridge, MA, 02139 USA
Email: prasanna, rahul_b and sesarma@mit.edu

Abstract—This paper presents a novel communication method for semi-passive RFID based sensors. The new method uses a digitally reconfigurable UHF RFID tag antenna to modulate sensed information at an RFID tag on to the received signal strength indicator (RSSI) response perceived at an RFID reader. This technique is completely compatible with the existing class 1 generation 2 UHF air interface protocol thereby enabling the use of existing RFID reader infrastructure to decode the additional sensed information. The effect of read distance, environment and bit duration on the performance of the communication method is examined through measurements obtained from a prototype. Through experimental verification, it is demonstrated that error free transmission of sensor information can be achieved up to 3.5 meters in different environments with a bit duration of 500 ms. Prospective future research directions are also discussed.

I. INTRODUCTION

Passive UHF radio frequency identification (RFID) technology is widely used for wireless automatic identification and information retrieval in many industries. Its superiority over competing technologies such as, optical 1D and 2D barcodes, magnetic strips, is achieved through the non-line of sight wireless operation at extended read ranges. Due to the advances in semi-conductor fabrication technology, passive RFID tags are mass produced at a very low unit cost (7-15 cents) [1].

Recently, RFID has attracted much attention in applications involving ubiquitous and pervasive sensing. Wireless communication in passive UHF RFID uses backscatter modulation [2] which consumes no energy at the RFID tag. Therefore, coupling a sensing functionality to these passive RFID tags provides a means for inexpensive deployment of a large amount of long life wireless sensor nodes for sensing applications, where energy is only needed to perform sensing and monitoring activities. However, the standardized wireless communication protocol (Gen-2) [3] that defines the communication between a UHF RFID tag and an RFID reader has no provisions for communicating the additional sensed information. Therefore, different approaches have been presented in literature for communicating sensed data from passive and semi-passive RFID tags [4]–[10].

In [7]–[10], a change in a physical parameter that needs to be sensed at an RFID tag is translated to an analog variation in the received signal strength indicator (RSSI) or response frequency at an RFID reader. This method only allows sensing of a few discrete levels or threshold violations in the sensed parameter. The authors of [5] integrate electronic sensors into the passive RFID and communicate the sensed information by modifying the 64-bit tag identification number (ID). Here,

because the RFID tag ID is modified for communicating information, the tag loses its unique identity to some extent. In [4], [6] the concept of tag ID-modulation is used, where circuitry at the RFID tag activates and deactivates different RFID tag integrated circuits (IC) for the modulation of information bits through the use of different IDs. This approach requires the use of multiple RFID tag ICs at the RFID tag and a complex RF switching matrix to switch between different ICs.

In this paper, a novel communication technique is proposed to communicate the sensed information by an RFID based sensor node through the use of low rate RSSI modulation. A reconfigurable UHF RFID antenna design that uses an RF switch is proposed to achieve the RSSI modulation. This simple RF design allows further miniaturization of semi-passive RFID based sensor tags. Also, the new method enables the deployment of UHF RFID based sensors that are sufficiently precise and cost effective. Furthermore, since the new communication protocol is completely compatible with the existing Gen-2 protocol the transmitted additional sensor information can be read by existing commercially available RFID readers without the need for hardware modifications.

II. SYSTEM MODEL

This section presents the system model of the new communication method based on RSSI modulation. Fig. 1 illustrates the standard communication between an RFID tag and an RFID reader. The reader transmits an interrogation signal at a power of P_t which energizes and activates the RFID tag. The tag then performs backscatter modulation to transmit its ID information to the reader according to the Gen-2 UHF air interface protocol [3]. The differential backscattered power P_b received at the reader from the tag can be expressed as [2],

$$P_b = P_t \left(\frac{G_{tag} G_{reader} \lambda^2}{(4\pi d)^2} \right)^2 \tau, \quad (1)$$

where G_{tag} and G_{reader} are the tag and reader antenna gains, d is the distance between tag and reader, λ is the carrier wavelength and τ is the power transmission coefficient which depends upon how well the RFID chip impedance is *matched* to the RFID tag antenna impedance. This received differential power P_b at the RFID reader is the RSSI.

In the proposed communication method, the RFID reader periodically interrogates the RFID tag based sensor at an interval of Δt . In each of these reader interrogations the tag responds according to the Gen-2 protocol. The tag communicates its ID to the reader at a particular RSSI as defined by (1). A typical tag response takes several milliseconds where each

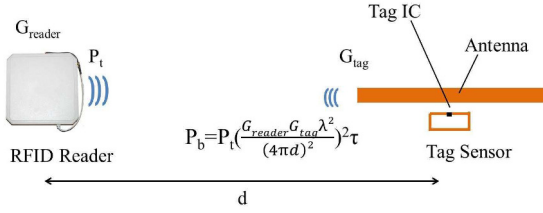

Fig. 1. RSSI response from an RFID tag.

bit period (known as a *Tari* [3]) varies from 6.25 – 25 microseconds. The minor grid lines shown in Fig. 2 (c) correspond to individual reader interrogation instances which are separated by a time of Δt . Over a multiple of these intervals, Δt , a sensed information bit, having a bit duration $T (\gg \Delta t)$, is communicated using a high or low RSSI level with the aid of a digitally re-configurable RFID tag antenna as shown in Fig. 2 (a) and (b). Through the use of the re-configurable RFID tag antenna, it is possible to control the value of τ to obtain the required RSSI level according to (1). It should be noted that the Gen-2 air interface protocol has bit periods in the order of micro-seconds, whereas the proposed RSSI modulation is performed at a much slower pace, where the bit periods, T , are in the order of several hundred milliseconds. Therefore, the proposed RSSI level modulation based communication mechanism operates above the Gen-2 protocol layer at a much slower rate as shown in Fig. 2(c).

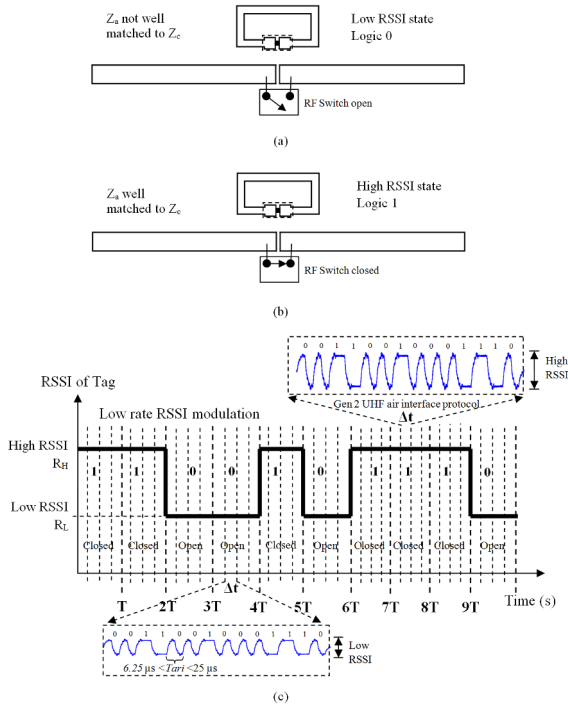

Fig. 2. (a) Low RSSI state of RFID tag (b) High RSSI state of tag (c) Transmission of information through RSSI modulation using the two distinct RSSI states.

III. PRACTICAL SYSTEM IMPLEMENTATION

This section details the practical implementation of the proposed communication method through the use of a digitally

reconfigurable antenna and a micro-controller based control system. The key to the operation of the RSSI modulation is the digitally reconfigurable UHF RFID antenna. The UHF RFID antenna has two states that can be selected using an RF switch. In one state, the antenna impedance, Z_a , is well matched to the RFID IC impedance, Z_c , resulting in a high τ and in the other state it is poorly matched resulting in a lower τ . As observed in Fig. 2 (a) and (b), the RF switch is used to digitally bridge the two arms of the radiating antenna element in order to implement the two states. When the switch is open, the poorly-matched state is achieved resulting in a lower RSSI, R_L , and when the switch is closed, the well-matched state is achieved causing a higher RSSI, R_H . Let $s_i, i = 1, \dots, M$ denote a sequence of M sensor data bits that need to be communicated by the RFID tag sensor where s_i can take a value of ‘0’ or ‘1’. These M data bits are communicated to the RFID reader through RSSI modulation where the RSSI level registered at the RFID reader due to the i -th data bit can be expressed as,

$$RSSI(i) = (1 - s_i) R_L + s_i R_H. \quad (2)$$

Fig. 3 shows the simulated power transmission coefficient of these two states obtained using full-wave electromagnetic simulation of the UHF RFID antenna. It is clear from these results that due to the change in τ in these two states, there is more than 9 dB difference in the RSSI.

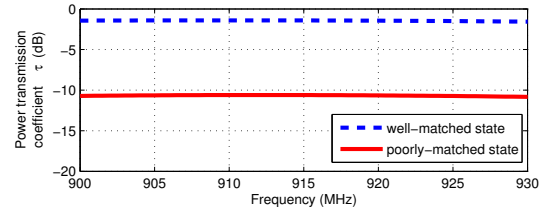

Fig. 3. Simulation result of the expected difference in RSSI due a reduction in power transmission coefficient τ for the two states of the digitally configurable RFID antenna.

The proposed RFID tag based communication and sensing platform consists of two sub-systems, (i.) signal strength modulator and (ii.) control logic and sensing platform. The total system is essentially a semi-passive RFID tag where the wireless communication between the tag and the RFID reader is powered by the reader interrogation signal and the functionality of the control logic and sensing platform is powered by an external power source (button cell battery) or an energy scavenging mechanism such as a solar panel. The complete RFID based sensing system platform is illustrated in Fig. 4.

A. Signal strength modulator

The signal strength modulator is essentially the digitally reconfigurable UHF RFID antenna. The antenna design is a variant of the inductively coupled loop RFID tag proposed in [9], [10]. The RFID tag consists of a 160 mm long radiating element which is split in the middle and an inductively coupled loop having dimensions 22 mm \times 11 mm and a width of 2 mm as seen in Fig. 4. The RFID tag was fabricated using adhesive copper tape having thickness of 40 μ m. An Alien Higgs 3 IC [11] was used for the RFID tag. A very low cost GaAs MESFET switch, RF2436 [12], was used as the RF switch.

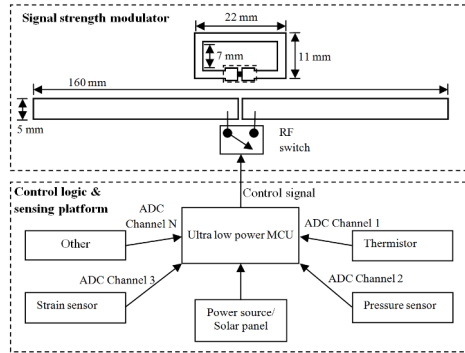

Fig. 4. RFID based sensing system using low rate RSSI modulation.

The switch can be closed and the well-matched state can be achieved by applying 0 V to its control pin (switch control) as shown in Fig. 5. The poorly-matched state is obtained by opening the switch through the application of a voltage greater than 0.7 V on the control pin.

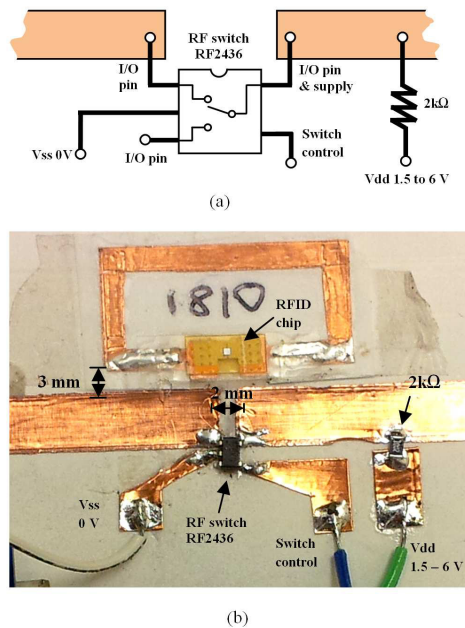

Fig. 5. Implementation of signal strength modulator using RF switch RF2436. (a) Schematic diagram (b) Actual fabricated circuit.

B. Control logic and sensing platform

This sub-system senses information periodically from the environment and presents this information to the signal strength modulator for transmission. The control logic and sensing platform is an embedded system implemented using an industrial micro-controller unit (MCU) which has provisions for sensing analog phenomena in the environment. By using an ultra low power small form factor MCU an extremely compact and long life system can be designed that can sense multiple physical phenomena such as, temperature, pressure, strain etc. as shown in Fig. 4. The control logic implements a protocol for error free communication of the sensor data via the signal strength modulator. The control logic maps the sensor data

bits, $s_i, i = 1, \dots, M$, to appropriate voltage levels required to drive the RF switch in the signal strength modulator so that $s_i = 0$ corresponds to a low RSSI and $s_i = 1$ corresponds to a high RSSI at the RFID reader.

C. New Communication protocol

As opposed to the Gen-2 communication protocol, the communication protocol proposed in this paper is one directional, where it only supports broadcasting of sensor data produced at the RFID sensor tag to an RFID reader using the two distinct RSSI levels. It does not have provisions for sending high level sensing control instructions from the reader to the tag.

The sensor data bits collected by the RFID sensor tag are arranged into data packets that conform to the packet structure shown in Fig. 6. These packets are then periodically transmitted through the signal strength modulator using the RSSI level modulation scheme. Each packet consists of a synchronization byte, a byte number indicator, data bytes, an N -bit cyclic redundancy check (CRC) and an end byte. The synchronization byte is used to find the starting point of the data packet. The indicator byte gives information on how many sensor data bytes are contained in the packet. The integrity of the data contained in the packet can be checked using the N -bit CRC. An end byte is also used to aid synchronization and to denote the end of the packet. For the proposed communication protocol to operate properly, the RFID chip used in the semi-passive RFID tag needs to maintain communication with an RFID reader for the whole duration of at least two data packets. This is to ensure the accurate identification of the starting point of a data packet using the synchronization byte and end byte. It should be noted that the least significant bit (LSB) of each byte is transmitted first in this protocol.

IV. MEASUREMENT RESULTS

This section presents the measurement results to validate the theory of operation of the proposed system and also evaluates the performance of the low rate communication protocol for different distances, bit durations, and environments. The measured RSSI is analyzed to reveal the proposed protocol structure.

The experiments were performed in two environments — in a cluttered room and in a hallway having open space. An Impinj Speedway Revolution RFID reader [13] was used to read the RFID tags where the transmit power level was set to 30 dBm. An Arduino development board [14] that contains an 8-bit Atmega328 MCU was used to implement the control logic and sensing platform of the prototype device.

A. Effect of distance

The effect of distance, d , between the RFID reader and the tag on the two RSSI levels, R_L and R_H , was examined. Table I shows the recorded statistical mean μ and standard deviation σ of the measured R_L and R_H at the reader for different distances. The statistics of R_L and R_H at each distance were calculated using over 1000 interrogations taken during 2 minutes, where the RFID reader was configured to interrogate the tag approximately every $\Delta t = 100$ ms. Here, the control logic of the semi-passive tag was configured to

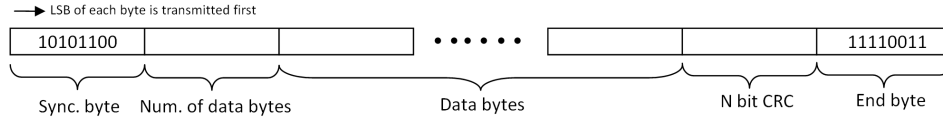

Fig. 6. Communication protocol used for transmitting information from RFID tag to reader using the low rate RSSI modulation.

simply flip between the two RSSI levels, where it stays at each level for a duration of 5 seconds ($T = 5$ s). The measured RSSI levels are also shown in Fig. 7 which clearly shows the flipping of the two RSSI levels with time.

TABLE I. HIGH AND LOW RSSI STATES FOR DIFFERENT DISTANCES

Distance d (cm)	High RSSI level R_H (dBm)	Low RSSI level R_L (dBm)
50	$\mu = -45.43, \sigma = 1.00$	$\mu = -58.25, \sigma = 1.23$
100	$\mu = -51.11, \sigma = 0.93$	$\mu = -62.46, \sigma = 1.02$
150	$\mu = -53.73, \sigma = 1.65$	$\mu = -64.84, \sigma = 1.17$
200	$\mu = -57.01, \sigma = 2.96$	$\mu = -67.55, \sigma = 0.50$
250	$\mu = -61.29, \sigma = 1.78$	Not detected
300	$\mu = -63.20, \sigma = 1.11$	Not detected
400	$\mu = -63.99, \sigma = 1.73$	Not detected

From the results shown in Table I and Fig. 7 it is clear that the strength of both RSSI levels, R_L and R_H registered at the reader reduce with distance. This reduction is mainly attributed to the increase in path loss with distance. Regardless of this reduction in signal strength with distance, a difference of more than 10 dB is observed between R_L and R_H for any given distance which is significantly higher than the standard deviation associated with the measurements. This demonstrates that these two RSSI levels can be utilized for the low rate communication scheme regardless of distance since there is a considerable difference between them enabling the two levels to be clearly distinguished. The value of σ at each distance is a measure of how much R_L or R_H has deviated from their mean values. From the results presented it is clear that at some distances (particularly at $d = 200$ cm) a considerable fluctuation is observed in the RSSI levels which we attribute to multipath effects. It is also observed that beyond a distance of $d = 200$ cm the strength of R_L becomes too low to be registered at the RFID reader where only the high RSSI level, R_H , is observed at the reader.

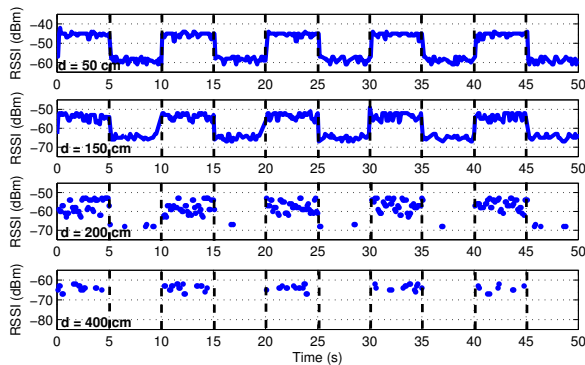

Fig. 7. Performance of flipping between two RSSI states for different d (50, 150, 200 and 400 cm). A bit duration of 5 seconds is considered.

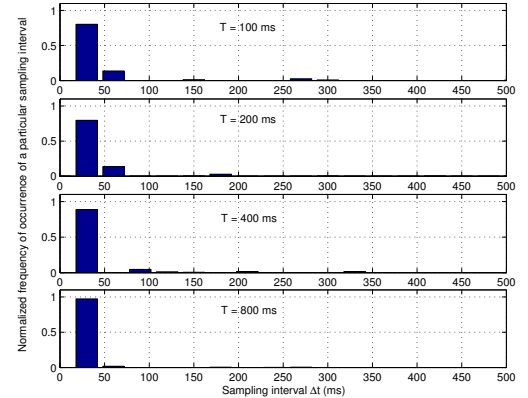

Fig. 8. Histograms of the different sets of Δt corresponding to different T with $d = 400$ cm.

B. Effect of bit duration

The bit duration of the proposed low rate communication protocol determines the data rate at which the sensor information is communicated to the reader. The choice of a bit duration T (cf. Fig 2(c)) affects the fidelity of the underlying Gen-2 air interface protocol. If an abrupt high-to-low ($R_H \rightarrow R_L$) transition of the signal strength due to the proposed higher layer communication coincides with a critical juncture in timing and synchronization in the underlying Gen-2 protocol, it would cause errors in the detection at the RFID reader where the entire Gen-2 data packet might have to be discarded. For a fixed Δt we hypothesize that the probability of occurrence of such errors would increase when T reduces since there will be more frequent $R_H \rightarrow R_L$ transitions. A smaller T would increase the data rate, however, it would result in more errors in the Gen-2 protocol layer. Therefore, the choice of T is a compromise between the average error rate that can be afforded and the acceptable data rate.

In order to prove the above hypothesis, experiments were conducted where the consistency of the interval Δt between tag interrogations was examined for different T . The RFID reader was configured to interrogate the tag approximately every $\Delta t = 30$ ms. Using the measurements, Δt values between consecutive interrogations were calculated. It was observed that the statistical properties of a calculated set of Δt values considerably vary with T . Fig. 8 shows histograms of different sets of Δt values obtained for different T with a tag-to-reader distance of $d = 400$ cm where each set contained 500 samples of Δt values. A large distance $d = 400$ cm was selected to purposely make R_L too low to be detected at the reader which artificially enhances the probability of errors happening when an $R_H \rightarrow R_L$ transition occurs. From the measured results it is clear that when the bit duration, T , is reduced, the observed Δt between consecutive interrogations more frequently deviates

from the expected value of 30 ms where considerably larger Δt are observed. These irregularities in Δt greatly reduces when larger T is used. For an example, in Fig. 8 when $T = 100$ ms and $T = 200$ ms the corresponding histograms show an 80% presence of samples having the required $\Delta t = 30$ ms. This presence increases for the sets obtained for $T = 400$ ms and $T = 800$ ms, where a percentage of 88.8% and 97.2% of the total samples respectively have a value of $\Delta t = 30$ ms. Irregular and longer Δt between consecutive tag reads can be attributed to the errors in the Gen-2 protocol layer where the RFID reader takes some time to re-synchronize after an error. These observations from the experimental results confirms the hypothesis presented earlier.

In order to extract the information transmitted through the low rate RSSI modulation scheme, the modulated waveform needs to be reconstructed at the reader using the RSSI information obtained from tag interrogations performed by the reader. Here, the time between consecutive tag interrogations, Δt , serves as the sampling time for the RSSI samples collected. According to the Nyquist sampling criteria in order to accurately reconstruct the RSSI modulated waveform shown in Fig. 2 (c), the sampling period needs to be less than half the bit duration of the waveform, $\Delta t < T/2$. When Δt is larger than $T/2$ there is ambiguity in the reconstructed waveform which might result in bit errors. Therefore, the bit error rate in the low rate modulation scheme caused due to irregular Δt is equal to the probability of the event $\Delta t > T/2$, which can be expressed as,

$$BER_T = P \{ \Delta t > T/2 \} \quad (3)$$

where BER_T is the bit error rate due to irregular Δt for a given bit period T and $P \{ A \}$ is the probability of occurrence of an event A . From the measured information presented as histograms in Fig. 8 the value of $P \{ \Delta t > T/2 \}$ can be calculated for the different bit periods, T . The calculated values are tabulated in Table II. From the tabulated information we

TABLE II. $P \{ \Delta t > T/2 \}$ FOR DIFFERENT T

Bit period T (ms)	$P \{ \Delta t > T/2 \}$
100	0.114
200	0.068
400	0.041
800	0

can conclude that when T increases the probability of bit errors reduce considerably. In addition to T the nature of the environment, whether it is cluttered or open and the presence of fading zones, will also affect the bit error rate. In this paper, the bit error rate measurements were conducted in an open room with clear line of sight between reader and tag. A bit period of $T = 500$ ms was chosen as a compromise between data rate (0.5 bps) and the probability of error ($BER_T < 0.041$) for the demonstration of the low rate RSSI modulation scheme.

C. Measured data packets

The control logic of the semi-passive RFID tag was configured to implement the protocol structure of the low rate communication shown in Fig. 6. Here, we demonstrate the communication of two sensor data bytes (byte number indicator has a value of two) where 1-bit CRC or even parity is used to check the integrity of the data. In order to emulate

two sensor inputs, voltages (1.25 V and 3.75 V) were applied to two ADC inputs of the MCU. These voltages generated the data bytes ‘00111111’ and ‘10111111’ respectively where the ADC full voltage span was set to be 5 V. Fig. 9 shows the measured first two consecutive data packets after powering up the semi-passive tag. It should be noted that since the LSB is transmitted first the bits of the received bytes appear in the reverse order. The tag was placed 75 cm in front of the RFID reader. Here, the bit duration is 500 ms and each packet contains 41-bits including the parity bit. The data bytes of the first packet were purposely initialized to all zeros so that they serve as a reference for demonstrating the actual data bytes that appear in the second data packet at the same slots in the protocol structure. It is clear from the figure that the measured packets perfectly conform to the proposed protocol structure and are accurately received at the reader.

Fig. 10 shows the received data packets for two cases where the experiment was performed in an open environment at $d = 100$ cm and in a room cluttered with metal reflecting surfaces and furniture at $d = 350$ cm. These tests are meant to emulate two drastically different types of environments in which the tag-sensor may need to communicate. Both levels, R_L and R_H , are visible in Fig. 10 (a) since the tag is placed closer to the reader. However, at $d = 350$ cm, shown in Fig. 10 (b), only the R_H level is visible where a large variation of the RSSI is also observed. These fluctuations can be attributed to multipath fading. Although these fluctuations are significant and R_L is not detectable, from the figure it is clear that the information can still be accurately detected. Here, periods where the tag is not detected are considered to be communicating an information bit ‘0’ and periods where the tag appears with a weak signal level ($R_H < -60$ dBm) are considered to be conveying an information bit ‘1’.

V. CONCLUSION AND FUTURE WORK

A novel RSSI-based low-rate modulation technique has been introduced for transmitting sensor information generated at an RFID sensor node to an RFID reader. The proposed method overlays and seamlessly extends the existing Gen-2 air interface communication protocol.

A digitally reconfigurable antenna design was used to create the two RSSI levels, R_L and R_H , required for the low-rate RSSI modulation. A protocol structure was proposed to convey sensing information. Using measurement results it was demonstrated that the technique operates reliably over a distance of 3.5 m. It was also demonstrated that, for a fast reader-tag interrogation rate of $\Delta t = 30$ ms and a bit duration of $T = 500$ ms, an acceptable trade-off between data rate and error-free communication can be achieved. The system performance was tested in two different types of environments — an open and congested room.

The RFID based sensing platform can be implemented very cost effectively. The RFID tag used in the system can be manufactured in bulk quantities for 7-15 cents. The MCU and battery/ solar panel would add not more than \$1.20 in costs. Accounting for an additional \$1 for miscellaneous components such as resistors and the RF switch, the entire sensing platform can be fabricated for less than \$2.50 per unit.

